

4:1 Tx Line Transformer 50-870MHz characterized in a 2.66:1 Z environment

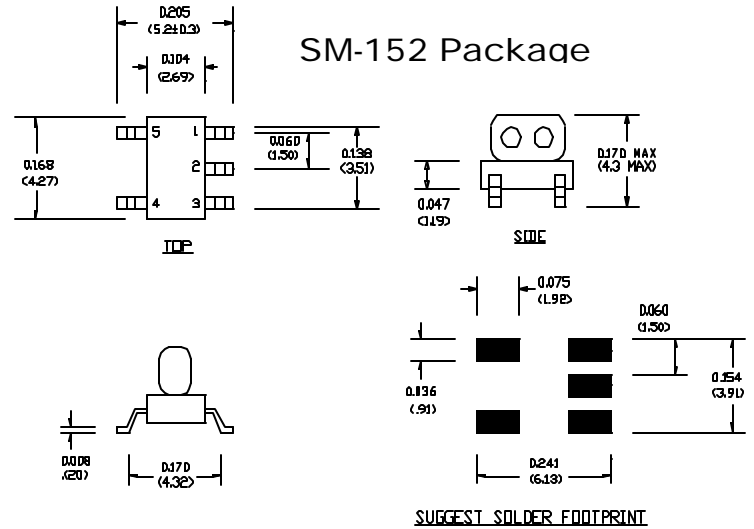

Features

- Surface Mount
- 4:1 Impedance
- Available on Tape & Reel

Description

M/A-COM's MABACT0017 is a 4:1 RF transmission line transformer in a low cost, surface mount package. The windings of the MABACT0017 are welded to the package substrate for improved reliability and reduced lead content. This Transformer is ideally suited for CATV and Satellite STB/Subscriber applications.

Dimensions in inches [mm] Tolerance: .xx ± .02, .xxx ± .010

Ordering Information

Part Number	Package
MABACT0017	Tape & Reel

Electrical Specifications @ 25°C, Z₀ = 75 Ohms

Frequency Range 50 - 870 MHz	Test Conditions	Nominal	Units	Min.	Typ.	Max.
Insertion Loss (Below the ref level)	50 - 150 MHz	—	dB	—	—	2.2
	150 - 650 MHz	—	dB	—	—	1.5
	650 - 870 MHz	—	dB	—	—	2.0
Amplitude Unbalance	50 - 250 MHz	—	dB	—	0.1	0.2
	250 - 650 MHz	—	dB	—	0.2	0.4
	650 - 870 MHz	—	dB	—	0.3	0.6
Phase Unbalance	50 - 150 MHz	—	°	—	2°	5°
	150 - 450 MHz	—	°	—	5°	10°
	150 - 450 MHz	—	°	—	8°	15°
Input Return Loss	50 - 870 MHz	—	dB	—	10	8

Note: Specifications subject to change without notice.

Absolute Maximum Ratings

Parameter	Absolute Maximum
RF Power	1 Watt
Internal Load Dissipation	0.125 Watt
Storage Temperature	-40° C to +85°C
Operating Temperature	-40° C to +80°C

Operating Characteristics

Function	Pin No.
Primary Dot (Input)	5
Primary (Ground)	4
Secondary Dot (output port1)	1
Secondary (output port2)	3
Center Tap (Ground)	2

Typical Performance @ +25° C

Insertion Loss Port 1 (Pin 5 to 4)

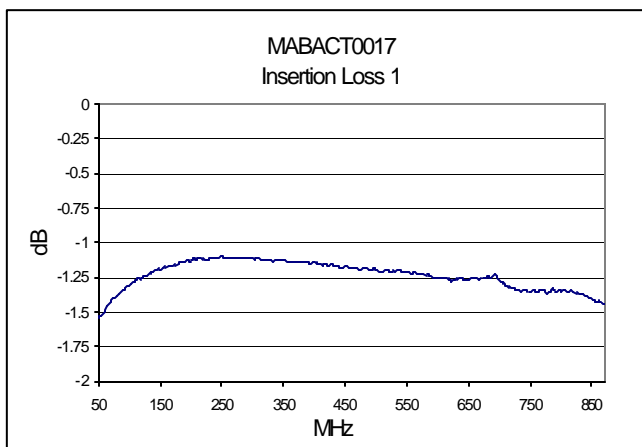

Insertion Loss port 2 (Pin 4 to 3)

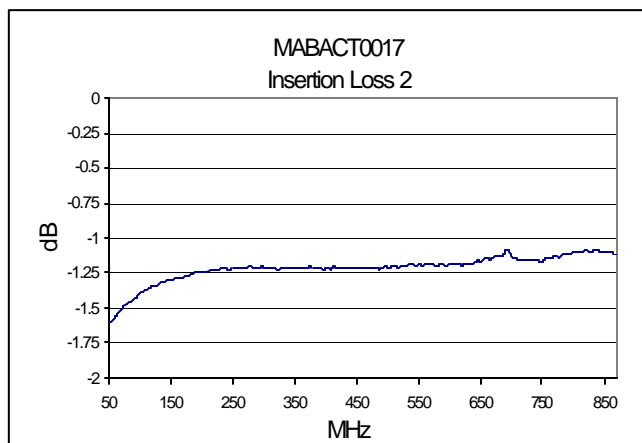

Schematic

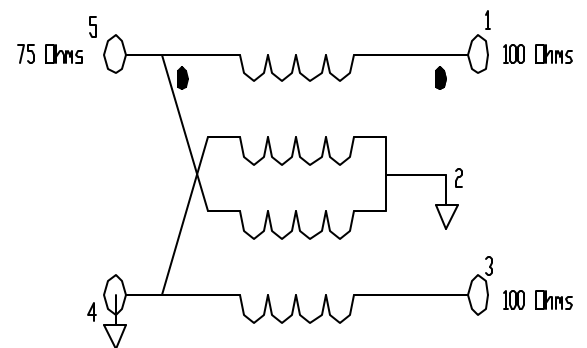

Note: Adjusted the Insertion Loss plots to remove the reference level.

Rev A

Specifications subject to change without notice.

- North America: Tel. (800) 366-2266, Fax (800) 618-8883
- Asia/Pacific: Tel.+81-44-844-8296, Fax +81-44-844-8298
- Europe: Tel. +44 (1908) 574 200, Fax+44 (1908) 574 300

Visit www.macom.com for additional data sheets and product information.

tyco / Electronics

MACOM

Amplitude Unbalance

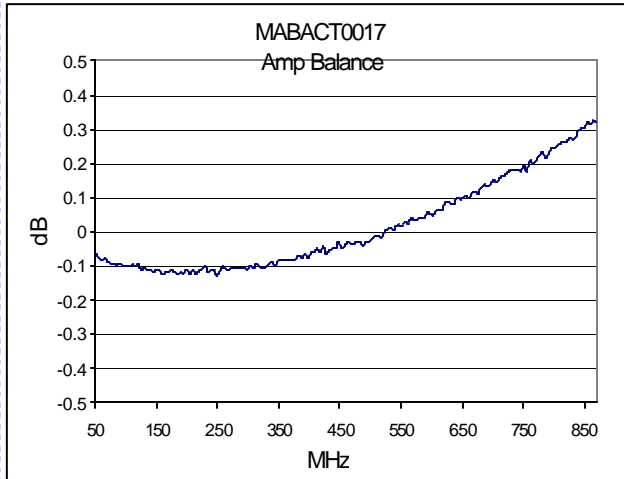

Phase Unbalance

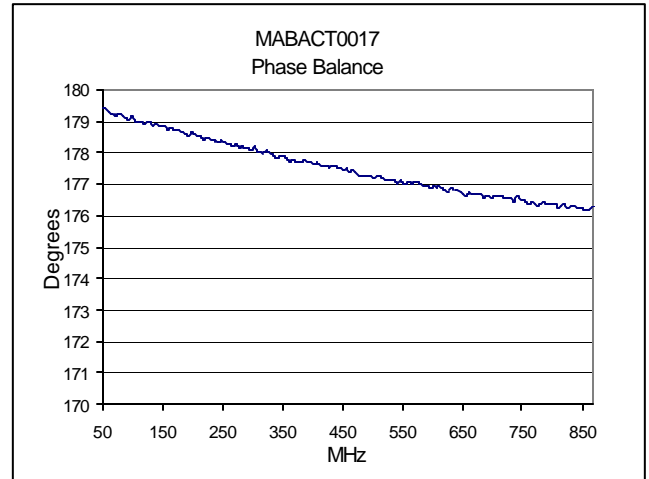

Input Return Loss

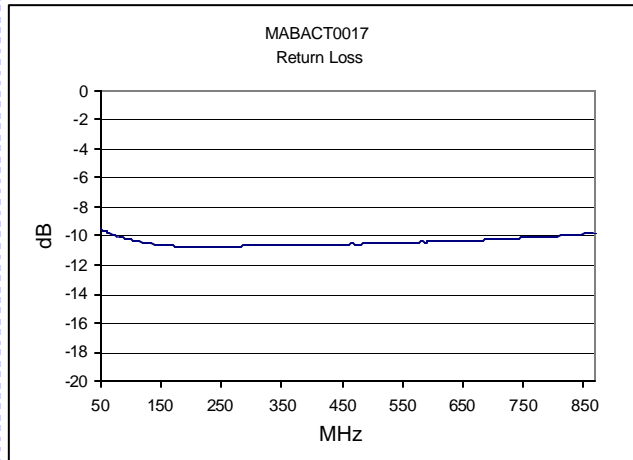

Rev A

Specifications subject to change without notice.

- North America: Tel. (800) 366 -2266, Fax (800) 618 -8883
- Asia/Pacific: Tel.+81-44-844-8296, Fax +81-44-844-8298
- Europe: Tel. +44 (1908) 574 200, Fax+44 (1908) 574 300

Visit www.macom.com for additional data sheets and product information.

